

# How to build

# cat proof fencing & cat enclosures

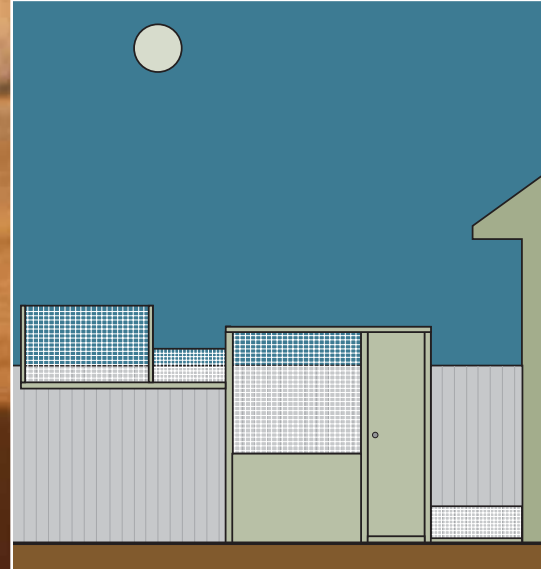
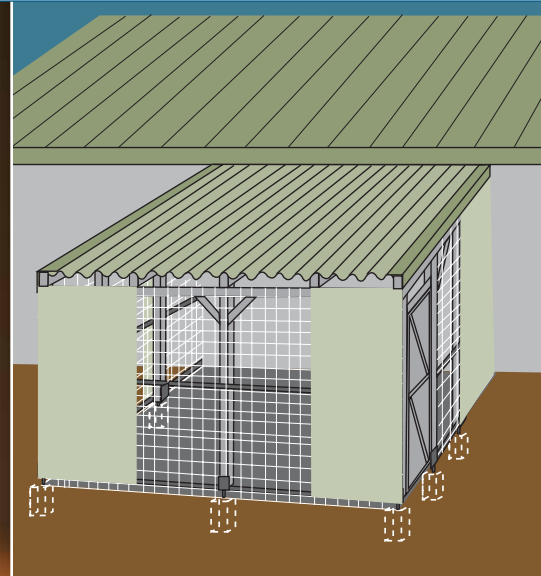

## Acknowledgments

Thanks to Bill Plant (mrdotster@gmail.com, phone 03 5722 1217), who prepared the building instructions for this booklet. Thanks to Annabel Woodward who volunteered to trial the cat proof fencing, and also to Wendy Height for trialing the cat proof fencing and in particular allowing us to test several different variations.

## Disclaimer

The content of this State of Victoria, Department of Primary Industries (DPI) document is provided for information purposes only. In particular, diagrams are illustrative only and may not be to scale. Information published by DPI is considered to be true and correct at the time of publication. Changes in circumstances after the time of publication may impact on the accuracy of this information and DPI does not warrant or represent that the information is free from errors or omissions or that the document is wholly appropriate for your particular purposes.

A person using the information should conduct independent enquiries to verify the accuracy of the information. To the extent permitted by law, DPI, its employees and agents shall have no liability (including liability by reason of negligence) to any person for any loss, damage, cost or expense (consequential or otherwise) incurred or arising as a result of any of the information, whether by reason of any error, omission or misrepresentation in the information or for any action taken by any person in reliance upon the information.

©The State of Victoria, Australia, Department of Primary Industries, 2006.  
ISBN 1 74146 684 9

# Introduction

Contrary to popular belief, cats don't have to roam. Providing their basic needs are met, cats can enjoy longer and healthier lives when safely contained to the property. They won't be hit by cars, injured in fights, become lost or catch fatal diseases such as feline AIDS. Containing cats to the property helps protect wildlife from predation, and prevents neighbourhood disputes about cat nuisance issues. Cat confinement is also a legal requirement with an increasing number of councils.

A number of excellent cat enclosure products are available commercially, however the cost of buying these can be a problem for some cat owners. This D.I.Y. booklet aims to help people who wish to save money by building their own cat enclosure or cat proof fencing.

At the time of publication, the cost of materials for building the D.I.Y. enclosures was approximately half the cost of purchasing similar (but already assembled) commercially available products.

This booklet provides instructions for building:

- 1) cat proof fencing (ie modifying existing fencing to make it 'cat proof', giving your cat free access to parts of, or your entire, yard)
- 2) a cat enclosure attached to another structure (ie the house or a shed), and
- 3) a free standing cat enclosure.

The instructions in this booklet should be easy to follow for people with basic D.I.Y. skills. Staff at your local hardware store may also be able to help answer any questions. However if you find the D.I.Y. instructions in this booklet too difficult, you could pay someone else to do the building, or buy a commercially available product (look under "Pet Shop Suppliers" in the Yellow Pages).

Most cats should adapt well to living indoors and in an enclosure, particularly if they have been kept in this way from an early age. However, adult cats used to roaming outdoors may have more difficulty in adjusting. If this is the case, you can consult your vet for advice. Desexing cats also reduces their desire to roam and helps prevent behavioural problems.

It is important to enrich the environment of cats, to prevent them from getting bored or developing behavioural problems. The next section explains how this can be done.

---

# Environmental enrichment

Cats have a number of basic needs that must be met if they are to stay happy and healthy.

**1 Companionship.** Cats require plenty of social contact with owners. This can be achieved by access to the house through a cat door (and tunnel if applicable). Set aside time each day to interact with your cat, for instance, patting, playing with, or grooming him/her.

**2 A well-informed owner.** You should find out as much as you can about cat behaviour and care. There are many useful books and websites available. For instance, visit [www.nssvet.org/ici](http://www.nssvet.org/ici) for information on cat care, indoor housing requirements, and solving behavioural problems. Talk to your vet about health and nutritional requirements for cats.

**3 Space.** Cats prefer to have their own 'personal space', and this is particularly important to prevent aggression in group housing situations. Each cat requires his/her own area that provides all the essentials (food, water, bed, resting places, litter tray etc).

**4 Sleeping, resting and viewing areas.** Cats like to spend a lot of time sleeping and resting in quiet areas where they feel safe and secure. Cat beds can be purchased, or blankets, towels, pillows etc can be provided. High sided cat beds and boxes are useful to give cats a sense of 'privacy'.

Cats use elevated areas as vantage points from which to observe their surroundings. These are essential, and can be provided by access to platforms, shelves, climbing posts or window ledges. Some cats love to watch birds (you can place a bird bath/feeder outside the window or enclosure), insects (try planting flowers to attract them), fish in aquariums and even nature footage on TV!

**5 Food and water.** Ensure bowls are located away from the litter tray. Many cats like having their water bowl in a separate area to their food bowl. Cats can also be given grass to chew (non toxic varieties such as oats, wheat, rye-grass).

**6 Litter boxes.** Each cat requires its own litter box, that is big enough for easy access and is located in a safe and private area (if a cat is startled while using the box, he/she may not use that box in future). You may have to experiment to find out your cat's preferences for covered or uncovered boxes, type of litter and depth of litter.

Cats are very clean animals that do not like using dirty litter boxes, so boxes will need to be scooped daily, and cleaned with water and non-scented soap once a week. A thin layer of baking soda placed on the bottom of the box will help absorb odours between scoopings.

**7 Scratching posts.** Scratching is a natural behaviour for cats, that sharpens claws, stretches muscles and leaves scent marks. Your cat will need a scratching post, which can be horizontal or vertical, and can be made from sisal (a coarse natural fibre), carpet, cardboard or wood. You can encourage your cat to use the scratching post (rather than other things like the furniture!) by putting catnip on it. Cats have an excellent sense of smell, and many cats love catnip, which can be supplied as a dried herb or grown fresh in pots.

**8 Toys and exercise.** Exercise your cat through play (or even by training your cat to walk outside on a harness and leash!). Cats enjoy toys that move or make noise, and remind them of prey such as mice, birds, and insects. They need a variety of toys they can roll, pounce on, capture and bite, and toys should be rotated regularly to prevent boredom.

Some examples of simple and cheap toys (that are safe for cats to play with) are crumpled paper balls, paper bags to explore, cardboard boxes, and toilet paper tubes. Try stuffing old cotton socks with cotton balls and some catnip, and tying a knot in the end. You can also buy furry toys (eg in the shape of a mouse) that make noises and can be rolled, balls (eg ping pong balls, or balls that can be filled with food or treats), sticks with toys dangling from the end of a string etc.

---

# parts



Cat proof fencing (ie modifying existing fencing to make it 'cat proof', giving your cat free access to parts of, or your entire, yard). [Page 2](#)



A cat enclosure attached to another structure (ie the house or a shed). [Page 6](#)



A free standing cat enclosure. [Page 12](#)

## Cat Proof Fencing

Have you considered cat proof fencing to keep your cat contained and safe? 'Cat proofing' your fencing provides your cat with free access to all or part of your yard. As an example, see **Figure 1** for a photo of a completed 'cat proof' fence.

If you have a small yard then this may be a better and cheaper alternative to building a cat enclosure. An ideal spot for cat proof fencing is that narrow area between the house and a fence that can be closed off at each end by gates.

### Some basic design considerations:

Cats should have access to the house through a cat door. If there are times when they are not able to access the house, they require access to a weatherproof sleeping area with a bed, and an adequate supply of fresh water etc while in the yard. There must be no dangerous items in the yard or sharp edges used in the fencing.

In most instances, fence extensions are legal as long as they are entirely on your side of the fence (ie not directly above the fence, or intruding over to the neighbour's side). However, some properties may have covenants in place restricting the height of fences – check with your local council to see if this applies to your property.

The first step in cat proofing your yard is to seal off all gaps in and underneath the existing fences and gates. Cats do not usually dig underneath fences. However if your cat shares the yard (or is next to a yard) with a dog that digs, then you may need to put a concrete or wooden plinth in the soil under the fence to prevent the dog opening up an escape route. In addition to 'cat proofing' your gates, lock any gates that are used infrequently and fit self-closing springs and latches to all other gates around the yard.

If you have a problem with other cats coming into your yard, you will have to watch to see if they are able to climb over the cat proof fencing. Most cats should find the netting too unstable to climb on. However if they can get in, you will have to ask your neighbour to install the cat proof fencing on their side of the fence too (to avoid visiting cats becoming trapped in your yard).

Before considering any treatment it is best to observe your cat's behaviour to see how it is escaping from the yard including any possible jumping points that the cat may use to clear the fence, eg material, equipment or objects placed near or against it.

Trees and shrubs can be trimmed back or alternatively a net barrier can be erected to block cat access to the launching place. Larger section tree trunks can be banded with a 600mm wide piece of sheeting (ensure this is at least 2 metres off the ground). Colourbond steel or clear polycarbonate is ideal. See Figure 2.

Following installation of cat proof fencing, it is important to supervise your cat carefully, until you are confident that it is not able to escape.

### Cat proof fencing - net barrier

#### Tools required

- Cordless drill,
- Tec screw driver bits
- Hammer
- Pliers
- Wire cutters or scissors

#### Materials

- Pipe supports
- Soft tie wire
- Tec screws
- Netting at 900mm width
- Staples or galvanised speed brace
- Wire clips
- Screws or masonry plugs

The pipes to support the netting can be made up by your steel supplier from 25mm tubing. Any flexible netting is suitable provided it is strong, UV stable and rot resistant.

The netting used Figure 1 is similar to a tennis net and has 50mm openings.

Ensure holes are small enough so your cat can't get its head caught in the netting.

See Appendix for details of a netting supplier. The key to the netting is that it is 'floppy' enough to feel unstable and unsafe for the cat to climb on. Therefore avoid using rigid netting such as galvanised mesh.



Figure 1: Completed fence

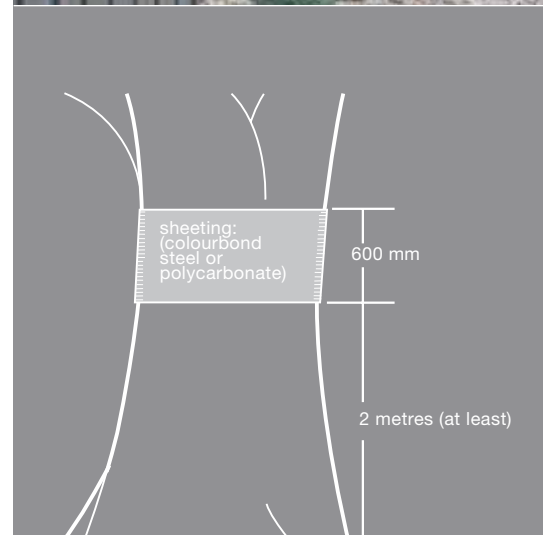

Figure 2: Tree banding

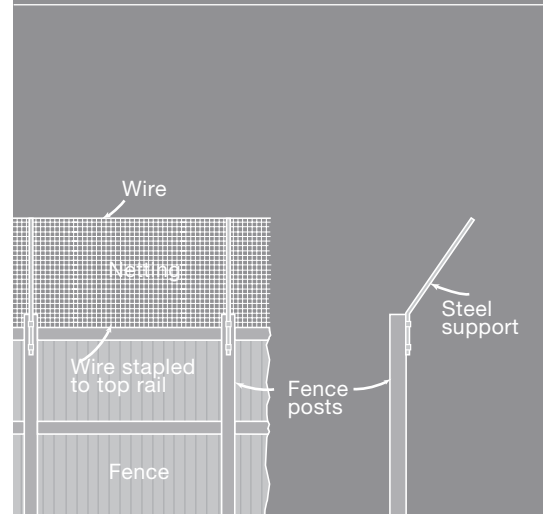

Figure 3: Completed steel support with netting

### Step 1 Measure and plan the project

Measure the required length of the 25mm tubing. The pipes will run vertically up the fence, before angling in towards the property (the angled section of the pipe should be 0.7 metres long and be on an angle of at least 35 degrees). See Figures 1 & 3 for examples. Netting at this angle is difficult for cats to climb over.

The total height of the fence including the netting structure should be at least 2 metres, to prevent the cat from jumping over it (some cats can clear 1.8 metres in a single jump!).

Calculate the number of supports required, and check prices with your supplier. Pipe supports need to be fitted on fence posts, corners and gates at no more than 2.8 metres apart.

Measure the length and width of the netting required. The netting will be affixed to the existing fencing and to the top of the angled section of pipe.

### Stage 2 – Painting

Before you start affixing the pipe supports, paint any non-galvanised steel with metal primer and paint.

### Stage 3 - Affixing

The supports are fixed to the fence with saddle clips or clamps. See Figure 4.

Drill a small hole in the top of each support and run a length of galvanised tie wire around the top through these holes. Fix the netting to the top wire with metal clips. See Figure 5.

The netting can be secured to the top of the fence with staples and a run of wire. See Figure 6. Staples attach the run of wire to the fence, and metal rings are used to attach the wire to the netting. Ensure the netting is secured to the fence at regular enough intervals so your cat will not be able to escape by squeezing between the fence and the netting. Alternatively, netting can be attached to the top of the fence using galvanised speed bracing. See Figure 7. This involves placing netting against the top of the fence and then securing it by applying speed bracing over the top.



Figure 4: Fixing support pipes



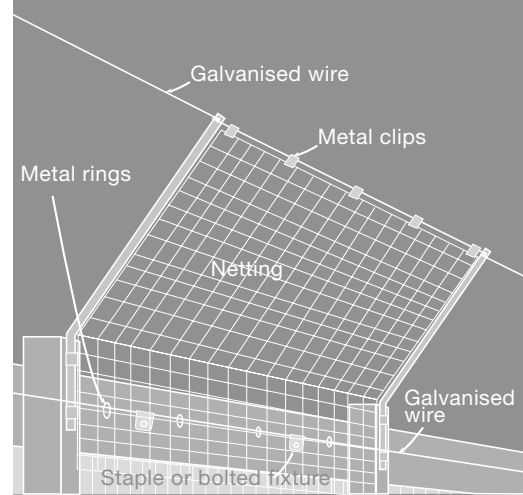

Figure 5: Securing the netting



Figure 6: Netting affixed to fencing with wire



Figure 7: Netting affixed to fencing with brace

## Appendix:

Supplier of netting (note there may be other suppliers who provide suitable prefab fittings, in addition to the supplier listed below)\*

### Oxley Nets

20 Network Drive

Port Melbourne, Victoria Australia

(03) 9646 3497, Toll free: 1800 816 505

[www.oxleynets.com.au](http://www.oxleynets.com.au)

\*The content of this Department of Primary Industries (DPI) document is provided for information purposes only. Information published by DPI is considered to be true and correct at the time of publication. DPI gives no representation or warranty as to the qualifications or suitability of the service providers listed, nor any representation or warranty that there are no other persons who provide services of this type as the list is not intended to be exhaustive.



## Cat enclosure attached to an existing structure

There are many options for this type of cat enclosure. The easiest solution can be to clad an existing pergola or patio with cat proof mesh, or fit a roof over a small-enclosed area such as a path between the house and fence. If you do not have a suitable area then we will show you how to build your patio style enclosure from the ground up and also show you a lightweight inexpensive alternative that can be constructed from galvanised water pipe and netting.

Read through the brochure and examine your options, then go ahead and design your project to suit your needs.

### Some basic design considerations:

- Cats must have shelter from sun, wind and rain (however they still require access to sunshine in the enclosure).
- Cats must have a weatherproof sleeping compartment with a raised bed (which must be kept in a clean and hygienic condition), along with a separate exercise area.
- The litter tray area must be well away from the cat's eating and sleeping areas and must be kept dry and be easily cleaned. Litter trays must contain an appropriate litter material and be cleaned daily (many cats will not use soiled litter, and will therefore soil elsewhere in the enclosure).
- Disinfectants containing phenol must never be used around cats.
- To prevent disease, your cat must be regularly wormed and vaccinated (as per veterinary recommendations), and flea control must also be undertaken. Accommodation should provide good ventilation, as this is vital to prevent build up of odours that can cause respiratory problems in cats.
- Hygiene and odour shouldn't be a problem as long as your cat uses its litter tray and the tray is cleaned regularly. However, in the event of your cat soiling the ground in the enclosure, you may have to consider adding some type of flooring. This could be as simple as installing small gauge wire mesh on the floor to prevent cats from digging and soiling in the dirt. Alternatively, you could install concrete or timber flooring that will also be easy to hose down.
- Cats require plenty of social contact with owners. This can be achieved by providing access to the house through a cat door (and tunnel if applicable).
- Each enclosure should provide a scratching pole and be designed to provide cats with at least two platforms at different heights. The platforms should be connected by static (eg planks) or swinging walkways. Cats should also have access to climbing frames and an interesting visual outlook.
- In a group enclosure a number of hiding and escape areas should be provided to enable cats to avoid aggression from other cats.
- The size of your enclosure will depend on the number of cats you wish to house, and how well they get on. The floor area of an enclosure must be at least 2 square metres for each cat, with a minimum height of 2 metres, plus tunnels and auxiliary enclosures. These dimensions are based on the presumption that cats will also have regular access to the house.

The first and most simple solution is to span an existing area, such as a section between the house and fence, a veranda, patio or courtyard, with a lightweight support system and cover it with netting. If you are covering a small span, say between a wall and a fence to make a roof frame, take the measurements to your hardware supplier who can advise you on suitable materials and fixing components. Although this option doesn't involve building a full patio type structure, we recommend you still read through the following instructions, and apply those that may be relevant to your particular project.

## Patio type structure

To span a wide area you will need to consider a typical patio structure - see [Figure 9](#) illustration. The most common patio type structure involves rafters fixed to the house or garage, and supported at the other end by posts. The posts are connected along the top by a timber plate, which supports the rafters. The best method of setting the posts into the ground is to bolt them in a galvanised stirrup set in a concrete footing. Battens are then nailed across these rafters and the cladding fixed directly to the battens. The basic structure is outlined in [Figure 1](#).

### Tools Required

- |  |                |                      |
|--|----------------|----------------------|
| – Drop saw                             | – Chisel       | – Handsaw            |
| – Spirit level                         | – Drill        | – String line        |
| – Shifting wrench                      | – Hammer       | – Shovel             |
| – Eye protection                       | – Tape measure | – Hearing protection |
| – Roofing square                       | – Ladder       |                      |
| – Tec screw driver, masonry/ wood bits |                |                      |

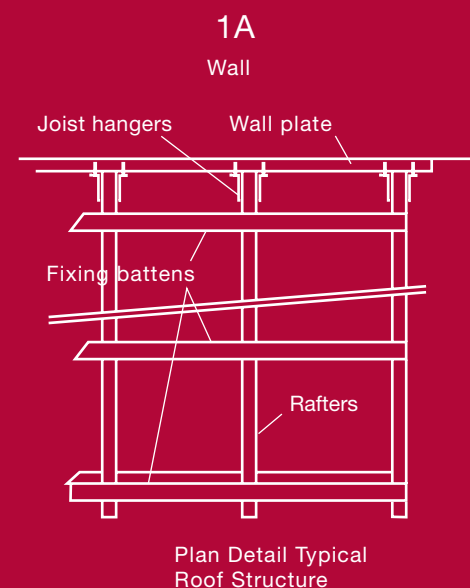

Typical Roof Structure – top view

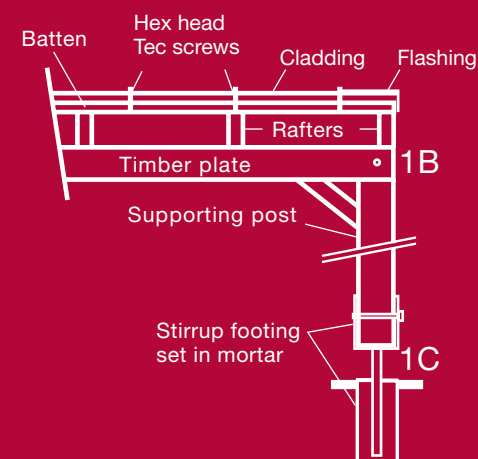

Figure 1: Typical Roof Structure – front view

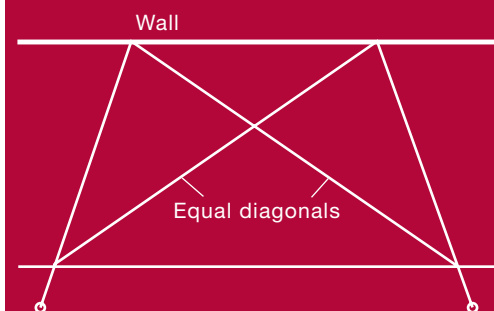

Figure 2: String line set out

## Material Checklist

Firstly, draw up a working sketch of your project and take it along to your local hardware supplier who will advise on the appropriate timber dimensions and spacings required for your particular application. Include this information in your drawing and check with your local council to see if a building permit is required.

Do not use treated pine in the structure as it may prove toxic to cats, especially if used as a scratching post. Typical timber dimensions and hardware requirements for an attached pergola approx. 4.8m x 3.6m:

- Top plate, 1-200 x 50mm
- Posts 3-100 x 100mm
- Braces 2-75 x 50mm
- Rails 2-75 x 50mm
- Wall plate 1-150 x 38mm
- Joist hangers 3-(attached to the wall plate as per photo)
- Battens 45 x 22mm, (typically fitted at 450mm centres)
- Framing brackets
- Rafters 6-150 x 50mm
- Post stirrups 3
- Concrete pre-mix
- Galvanised nails and bolts

## Construction

### Step 1 – Set out

To set out the full size plan on the ground, place a string line parallel to the house along the outside edge of the patio. Now set 2 string lines at right angles to the house at each end of the enclosure. Check the set out is square by comparing corner-to-corner measurements, ensuring that they are equal. See [Figure 2](#).

Allow spacing of 3 metres or less between posts and mark their position along the outer string line. Walk around your set out to check dimensions and proportions.

### Step 2 – Setting the stirrup post supports

Dig 200 x 200mm holes to a depth of 300mm for each post. See [Figure 1C](#).

Prepare the premixed concrete and fill the holes. Push the post supports into the concrete ensuring that the stirrup is above the ground level. This will allow water to drain away from the bottom of the posts and prevent rot.

Align each post support to the string line ensuring that they are all level and square. Leave the concrete to cure to specification.

Drill and bolt the posts in position and secure each post upright with temporary bracing. House (check in) and bolt the 200 x 50mm timber plate in position across the length of the posts and brace the end posts to the top plate with 150 x 50mm bracing bolted at 45 degrees. See [Figure 3](#).

**Please Note:** If you are fixing the posts onto an existing slab use post supports with a flat plate on the bottom. These are bolted in position with expanding masonry plugs. Your local hardware attendant can show you this method.

### Step 3 – Attaching a pergola to the house and fixing rafters

First fit a wall plate to the house, this wall plate is fixed to the wall of a brick house under the eaves with masonry plugs, or to a timber house with coach bolts screwed through the weatherboards and into the frame. The rafters are then fixed to the wall plate with joist hangers, and span across to the top plate at approximately 600mm intervals or less and fix with framing brackets or skew nails. See [Figure 4A](#).

### Step 4 – Fixing Battens

Battens are evenly spaced across the rafters at approximately 900 mm intervals or less and nailed in position with galvanised nails. Battens should be predrilled to avoid the timber splitting.

### Step 5 – Access door

The door is a simple brace and rail construction made from hardwood bolted together with galvanised bolts and clad with mesh. The door is hung between two vertical posts with a header bolted across at door height. If there are any children around then consider a childproof latch on the external door. See [Figure 5](#).

## Step 6 – Finishing the timber structure

Remember that treated pine is not an option so you will need to seal the timber to protect it from weathering with a good quality exterior finish. Paint the internal faces of the joints before assembly.

## Step 7 – Roofing/weather proof cladding

Note that in some cases it may be a legal requirement that a licensed plumber is required to fit the roofing and flashing (contact your local water supplier for details).

### Corrugated steel products

Zincalume and Colourbond sheeting can be used for roof and partial wall cladding. If you live by the coast then specify corrosion resistant steel sheeting. These products are easily fixed, however the structure must be sound. They are weatherproof and permanent but do restrict natural light, which is a consideration when enclosing an external wall containing windows. In this situation, clear polycarbonate sheeting such as Laserlight and Suntuff is an ideal solution. There is a wide range of grades available, which have differing light and heat transmission characteristics. Each product comes with specific fixing instructions, which must be followed. Remember that some part of the enclosure must provide cats with access to sunshine, while other areas must give shelter from the sun.

If you are likely to climb on polycarbonate roof cladding, you may wish to install a safety barrier directly underneath the material to prevent accidental falls. Ask your supplier to recommend a light wire mesh that can be fixed on top of the battens. The sheeting and end flashing is then fixed to the battens with self-tapping Tec screws and rubber washers.

You may want to consider installing guttering and a downpipe, if excess water run-off from the enclosure roof is a problem. The gutter should be fixed just below the line of the roofing, across the outside of the end beam. Remember to allow for a second fall, so rainwater can run along a slight slope in the gutter and flow into the downpipe. The pipe needs to be attached to the nearest stormwater outlet. Seek advice from your local hardware store, or contact a qualified plumber if you need assistance with installing a gutter and downpipe.

## Step 8 – Wall Cladding options

- Galvanised welded mesh is rustproof and available in a wide range of sizes and gauges. The maximum mesh size recommended for cat enclosures is 50 x 50 mm. A well-fixed 4-gauge mesh will provide reasonable security for your enclosure and is strong enough to support climbing plants should you wish to add them. Metal mesh is fixed to the timber posts and timber rails with staples or washers and Tec screws depending on mesh sizes and loading. See [Figure 6](#). Light flexible mesh is held in position with a timber batten nailed to posts or your existing structure (eg house or fence). Ask your mesh supplier to advise on the optimum fixing method for your application.
- Lightweight 25 x 25 mm mesh makes a good barrier where security is not a consideration. The mesh can be fixed with washers and Tec screws.
- Galvanised chicken wire is a cheap alternative and is fixed with battens anchored to the base structure.
- Shade cloth is available in a wide range of colours and opacities making it a good option for your enclosure. It has good UV stability and will last for years, however it should be checked occasionally for signs of weakness. It is fixed to the structure with special fasteners that are available from your shade cloth supplier. Shade cloth walls are prone to damage from climbing cats and can be strengthened with metal mesh. Remember that some part of the enclosure must provide cats with access to sunshine, while other areas must give shelter from the sun.
- Insect screening can be incorporated into the structure but it needs to be supported by a stronger mesh.
- Commercial netting products. Any netting is suitable provided it is strong, UV stable and rot resistant. Access doors can be sewn in with a zip fastener. See supplier list, ([appendix 1](#)).

**Please Note:** If netting is to be used to clad the enclosure then a wooden board needs to be set into the ground around the perimeter of the enclosure.

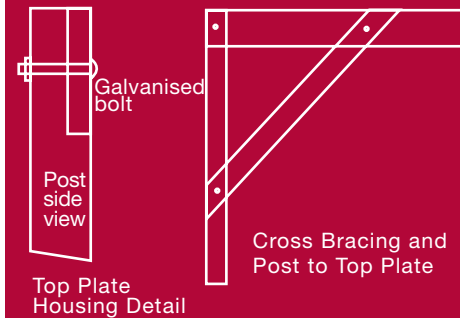

Figure 3: Top plate housing

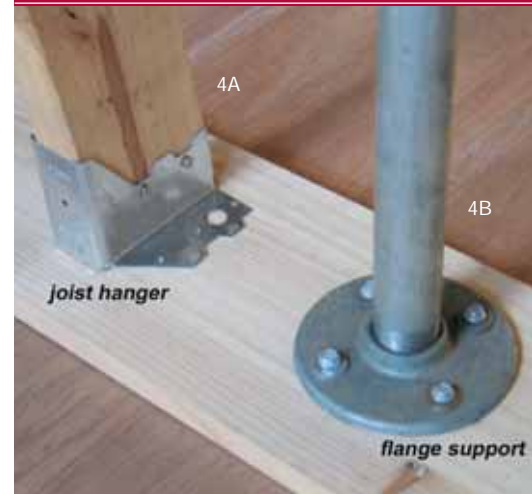

Figure 4A: Fixing method for timber

Figure 4B: Fixing method for galvanised steel tubing

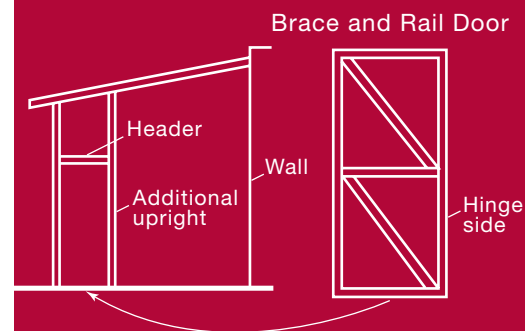

Figure 5: Door detail

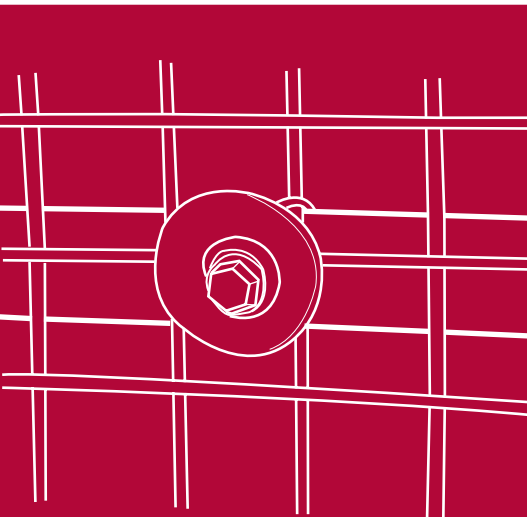

Figure 6: Fixing light mesh

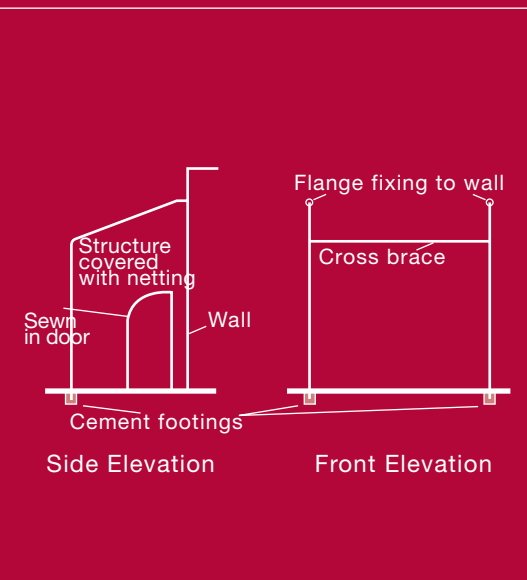

Figure 7: Tubular steel enclosure



Figure 8: Prefab pipe fitting

## Alternative lightweight enclosure

This enclosure is a lightweight alternative to the patio structure and is intended to be covered with flexible netting that has a sewn in door. The structure will not support a roof and is unsuitable for other mesh cladding. This type of lightweight enclosure is only suitable for situations where the cat has constant access to the owner's house through a cat door, so it can seek shelter during inclement weather. See [Figure 10](#) illustration.

The frame is made from round galvanised steel tubing that is bent at an angle, fixed to the wall at the top, and set in concrete pads in the ground at the other end. See [Figure 7](#).

To provide lateral support, the structure will need to be cross-braced or fixed to something solid, for example a fence.

The recommended wall fitting is a metal flange that is threaded onto the pipe and fixed to the structure by means of coach bolts or masonry plugs. See [Figure 4B](#).

The other end of the pipe is set into a concrete footing. Bracing is attached with prefab pipe fittings that are readily available from your supplier. See [Figure 8](#).

The structure can be covered with a prefabricated flexible netting cover with a sewn in zippered entrance ([appendix 1](#) for details of a supplier of netting products).

### Tools required

- Shovel
- Drill
- Masonry or wood bits
- Spirit level
- Roofing square
- Shifting spanner

### Materials required

- Galvanised pipe
- Screw on flanges
- Coach bolts or masonry plugs
- Concrete pre-mix
- Prefab pipe fitting (see [Figure 8](#))
- Flexible netting cover
- Tie wire

### Step 1 – Basic Design and Pre-fabrication

Draw the basic plan and discuss it with your steel supplier who can recommend the optimum pipe diameter, usually around 50mm. Have the pipe cut to length and bent. Based on your design identify pipes that need to be threaded on the top end to suit the screw-on flanges for fixing and have them threaded at the time of purchase.

Most suppliers have a delivery service for those hard to handle components.

### Step 2 – Set out

Start construction with a string line parallel to the supporting wall at the outside perimeter and another 2 string lines at right angles to the wall marking each end. See [Figure 2](#).

### Step 3 – Setting the frame posts

Dig the footings and erect the structure ensuring that it is well braced.

Take a spirit level and with a good eye, sight all pipes from all angles to make sure that they are in alignment with each other and in alignment with the support structure. Take care with this stage, as a poorly aligned frame can look shoddy.

Fit the bracing to square the frame and level the top bars by packing the bottom of the pipes with small rocks in the footing holes. When you are happy that everything is straight and square, mix up a quantity of premix cement and pour the footings. Allow to set to specification.

Set a wooden board into the ground all around the perimeter. The prefabricated netting cover will be fastened to this board.

Measure the finished project for the prefabricated netting.

### Step 4 – Fixing the netting

The netting is tied to the frame with galvanised tie wire. It is fixed to wood and masonry with battens, as for patio structure.

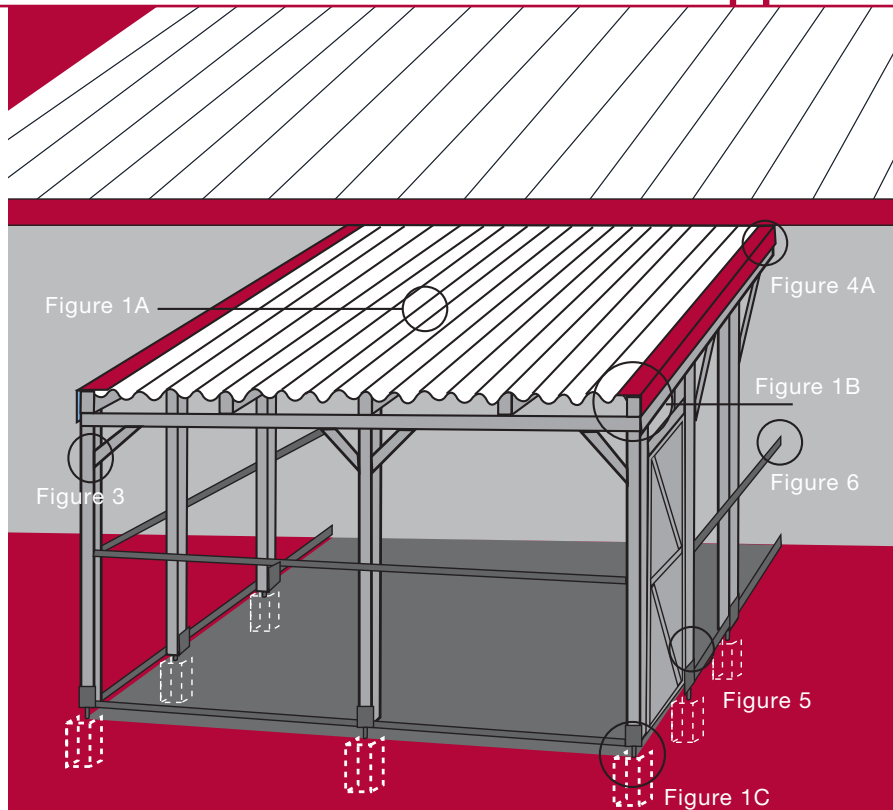

Figure 9: Patio type structure. This shows the basic building structure prior to the addition of solid weatherproof wall cladding on parts of the enclosure (to provide the cat with shelter) and prior to the addition of other features (platforms, climbing planks, scratching posts, beds etc) as described in the text.

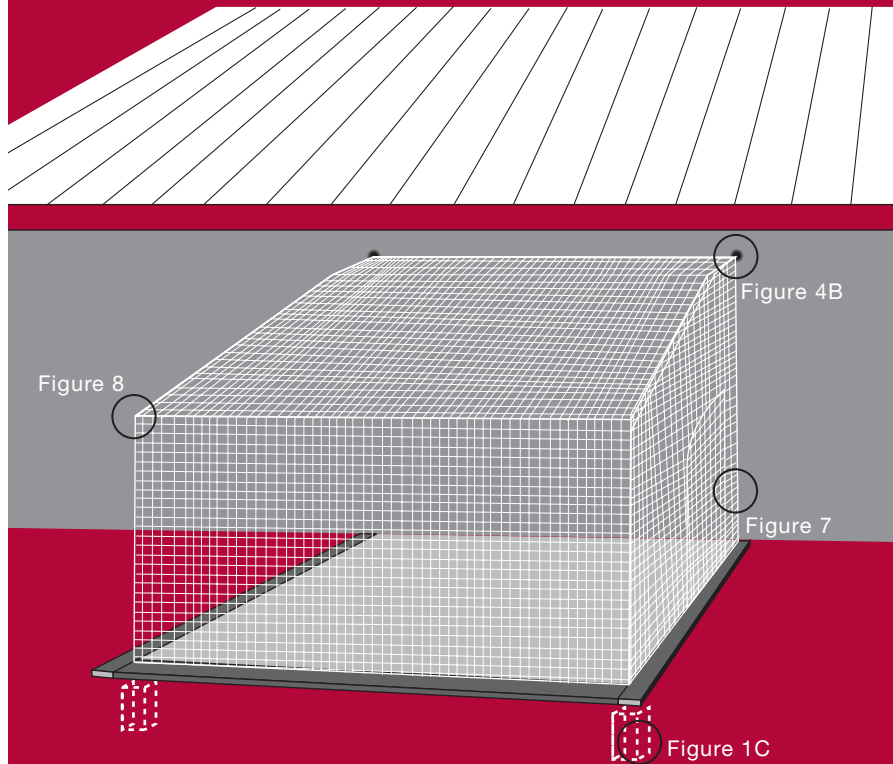

Figure 10: Alternative lightweight enclosure

**Appendix 1:**

Netting products (note there may be other suppliers who provide suitable netting, in addition to the supplier listed below)

**Oxley Nets**

PO Box 128 Port Melbourne Victoria 3207  
 20 Network Drive, Port Melbourne, Victoria  
 (03) 9646 3497, Toll free: 1800 816 505  
[www.oxleynets.com.au](http://www.oxleynets.com.au)

The content of this Department of Primary Industries (DPI) document is provided for information purposes only. Information published by DPI is considered to be true and correct at the time of publication. DPI gives no representation or warranty as to the qualifications or suitability of the service providers listed, nor any representation or warranty that there are no other persons who provide services of this type as the list is not intended to be exhaustive.



## Free standing cat enclosure

Cats love to move around and keep watch over their territory. They need a warm dry bed and somewhere to laze in the sun. By building your own cat enclosure you can tailor it exactly to the needs of your cat. Cats love the variety that this system of enclosure provides, especially if it is linked to the family home through a cat door. To help you design the layout to suit the space that you have available on your property we give you detailed instructions on how to build a basic enclosure together with add on auxiliary enclosures and linking tunnels that you can mix and match to make the perfect enclosure.



### Some basic design considerations:

- Cats must have shelter from sun, wind and rain (however they do need a sunny spot within the enclosure).
- Cats must have a weatherproof sleeping compartment with a raised bed (which must be kept in a clean and hygienic condition), along with a separate exercise area.
- The cat litter tray area must be well away from the cat's eating and sleeping areas and must be kept dry and be easily cleaned. Litter trays must contain an appropriate litter material and be cleaned daily (many cats will not use soiled litter, and will therefore soil elsewhere in the enclosure).
- Disinfectants containing phenol must never be used around cats.
- To prevent disease, your cat must be regularly wormed and vaccinated (as per veterinary recommendations), and flea control must also be undertaken. Accommodation should provide good ventilation, as this is vital to prevent build up of odours that can cause respiratory problems in cats.
- Hygiene and odour shouldn't be a problem as long as your cat uses its litter tray and the tray is cleaned regularly. However, in the event of your cat soiling the ground in the enclosure, you may have to consider adding some type of flooring. This could be as simple as installing small gauge wire mesh on the floor, to prevent cats from digging and soiling in the dirt. Alternatively, you could install concrete or timber flooring that will also be easy to hose down.
- Cats require plenty of social contact with owners. This can be achieved by providing access to the house through a cat door (and tunnel if applicable).
- Each enclosure should provide a scratching pole and be designed to provide cats with at least two platforms at different heights. The platforms should be connected by static (eg planks) or swinging walkways. Cats should also have access to climbing frames and an interesting visual outlook.
- In a group enclosure a number of hiding and escape areas should be provided to enable cats to avoid aggression from other cats.
- The size of your enclosure will depend on the number of cats you wish to house, and how well they get on. The floor area of an enclosure must be at least 2 square metres for each cat, with a minimum height of 2 metres, plus tunnels and auxiliary enclosures. These dimensions are based on the presumption that cats will also have regular access to the house.

A basic walk in unit is an essential start to your design and should incorporate a weatherproof sleeping compartment with a raised bed or hammock, together with a specific feeding area. Don't forget to provide a separate bowl for each cat.

This basic unit can be linked to one or a number of auxiliary enclosures by means of wire tunnels – see [Figure 10](#) for an example of a finished free standing cat enclosure. The enclosures are made from an open welded mesh and can be used to keep the litter tray well away from the main eating and sleeping area.

## Base unit

The base unit is constructed around a simple steel frame welded from square section tubing, and includes a walk in door for cleaning. The unit is clad with a combination of steel sheeting and wire netting.

See [Figure 10](#) for an example of a finished free standing cat enclosure, including a base unit.

The frame can be welded, which is easy to learn so if you can borrow a welder and get some instruction, spend time with scrap steel and practice. You will be surprised just how enjoyable and easy it is. The easiest welding position for a beginner is to weld a horizontal joint, so it is a good idea to turn the work where possible to present a flat welding position.

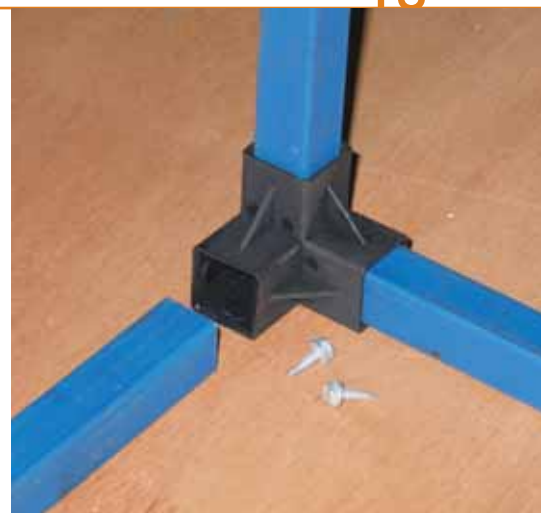

Figure 1: Prefab frame fitting

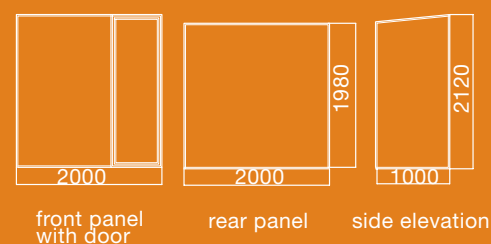

Figure 2: Steel frame for base unit

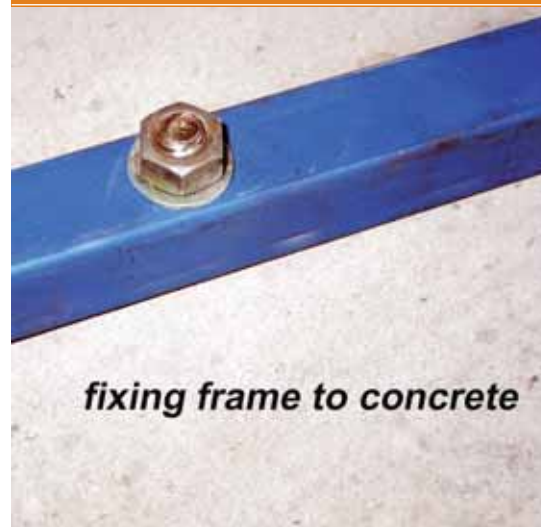

Figure 3: Fixing frame to concrete

If however you do not have access to a welder, either have the frame made for you at a local engineering shop, or alternatively you can use prefabricated fittings, which are available from specialist welding and engineering workshops. They can also supply and cut square steel tubing to suit the fittings. The fittings come in a range of configurations, such as tee joint, corner joint, and right angle that will be used in your design. The square tubing slips neatly into the joint and is fixed with a self-tapping Tec screw or pop rivet. See [Figure 1](#).

### Tools required

- Cordless Drill and bits
- Tec screw driver bit wheels
- Pop rivet gun
- Roofing square
- Tape measure
- Tin snips
- Handsaw
- Pliers
- 8mm masonry bit
- Bolt cutters (450mm minimum length)
- F clamps with plastic feet
- Angle grinder with cut off and grinding wheels
- Safety goggles
- Leather gloves
- Welder, (note that welding is optional)
- Welding magnets
- Welding hammer
- Welding mask

### Material Checklist

- 25 x 25 mm square tubing, primed
- 25 x 25 mm galvanised mesh
- Scrap steel offcuts
- 50 x 50 mm galvanised mesh
- Trimdec capping
- Tec screws and washers
- Zincalume or Colourbond fence sheeting
- Hinges
- Latch
- Tie wire
- Primer and paint
- 8mm Dyna-bolt

## Construction

### Step 1 - Design

First read through the step-by-step instructions to familiarise yourself with the component units and the construction techniques and then establish the number and type of units that you require.

Go outside and decide on your preferred layout, marking it out with pegs, paint or tape. See "Cat enclosure attached to an existing structure" section, Construction Step 1, for an example of a stringline set out. It is a good idea to leave this set out overnight, and return the next day with fresh eyes and ideas. Once you have decided on your layout, draw a simple plan to work from on 1cm x 1cm square graph paper to give you a 1:100 scale drawing. Use the plan to make up a materials and cutting list and set to work, following the simple step-by-step instructions.

## Step 2 - Prepare a cutting list

Working from your plan, prepare a materials and cutting list. Here is a sample-cutting list that has been taken from the drawing of the basic unit in [Figure 2](#) which constructs an approximate 1 x 2 metre enclosure (which is the minimum size per cat – see “Design Considerations” for details).

Prepare a similar cutting list from your plan.

Material 25X25mm tubing	Quantity	Size
Front panel uprights	2	2050 mm
Door jamb	1	2050 mm
Top and bottom rails	2	2000 mm
Door	2	1980 mm
	2	680 mm
Rear panel uprights	2	1900 mm
Top and bottom rails	2	2000 mm
Roof support	2	1060 mm
Bottom side rails	2	1000 mm

Cut 25 x 25 mm square tubing to length with angle grinder and cut off wheel ensuring that all cuts are square. Alternatively, your steel supplier can provide tubing cut to size and give you clean accurate burr free joints that are easy to weld.

## Step 3 - Assembling the steel frame

### Welding

Lay out the components for the front frame on a flat surface and tack weld the joints. Check the joints are square with a roofing square and finish the welds. Make up a door to suit the opening. Lay the door in position and fix to the doorframe by welding hinges and latch.

Using this finished frame as a jig, lay out the back frame components on top and weld the joints.

To join the front to the back it is best to enlist another pair of hands to hold everything in position. Weld the two bottom rails in position, and gently tip the structure on its side and weld the roof joints, continually checking for square as you go. Now weld in the internal brackets for fixing points for beds, climbing ramps, feed or water stations. The structure may appear a little unstable at this stage, but there is no need to worry, as the cladding will provide adequate bracing when fixed. Check all joints and grind off any excess welds and burrs. Prime the joints with metal primer and then finish with a good exterior paint.

### Welding tips

- Have water handy when welding to cool the welds.
- A welding magnet can be used to hold components in place when tack welding joints.
- If you are using an arc welder then pick off the slag from the welded joint as you go and re weld where necessary.
- If you live in a coastal area specify a salt resistant sheet steel cladding.

### Alternative to Welding

When using prefabricated joiners, see [Figure 1](#), follow the same construction order, fixing each joint as you go. Use self drilling Tec screws or bolts to attach the door hinges, latch and fittings and finish the frame with a good quality exterior paint.

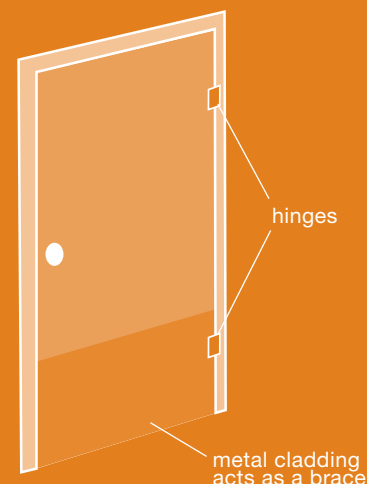

Figure 4: Door closeup

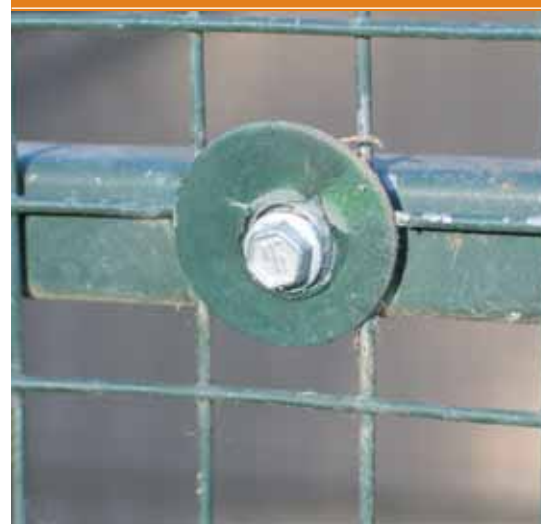

Figure 5: Fixing light mesh

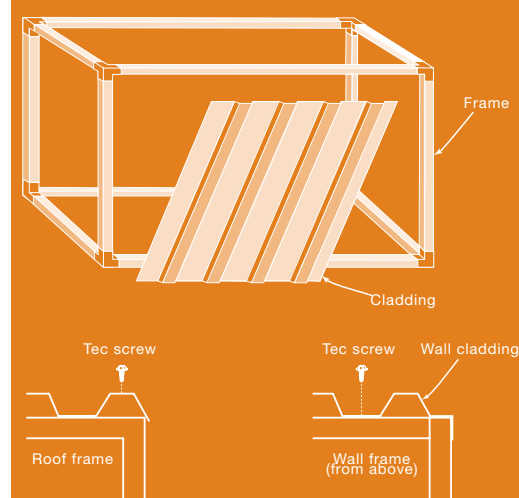

Figure 6: cladding

## Step 4 - Installation

If fixing on a concrete base, first check for square by measuring corner to corner. See "Cat enclosure attached to an existing structure" section, Construction Step 1, for an example of a stringline set out. Fix the bottom rails with 8mm Dyna-Bolt. See [Figure 3](#).

Where there is no concrete base, fix the frame directly to the ground with tent pegs driven through holes drilled in the bottom rail.

## Step 5 - Door

If you find that the finished door lacks rigidity then clad the bottom section with metal cladding which will act as a brace. The hinges and latch are fitted to the frame on the outside with welds or self drilling Tec screws. See [Figure 4](#). Give some thought to a childproof locking system.

## Step 6 - Cladding

First establish the shelter requirements for your base unit and plan which areas will be covered with sheet steel and with wire mesh.

### Mesh.

Cut each metal mesh panel to size and fix with self drilling Tec screws and washers. See [Figure 5](#). Do not fix the edges that will be later covered with the steel cladding.

### Sheeting

Calculate the sheet sizes required, bearing in mind that the standard cover is 760mm per sheet. The material is available in a range of stock lengths that you can cut to size with an angle grinder and cut off wheel. The cladding is fixed with self-tapping Tec screws and a cordless drill. Fix the first panel along the upright steel corner frame and check that the frame is square and then clamp the panel to the horizontal rails. Check again and then fix these edges with the Tec screws. Continue fixing around the frame until completed. See [Figure 6](#).

### Roof

Measure the roof opening from corner to corner to check for square and fix the roof panels across the narrow width. When affixing roof sheets, tec screws must be used on the high points of ridges in the roof cladding. Now cover the exposed edges of the roof cladding with 'U' section steel capping, using self drilling roofing Tec screws. See [Figure 7](#). However it should be noted that larger enclosures may require extra roof support.

## Auxiliary mesh enclosures

These freestanding units are constructed from 50 x 50mm galvanised welded mesh, wired together with galvanised tie wire. The size and shape of each enclosure will depend on your requirements and also the stock sizes of mesh that is available from your supplier. Common sheet sizes are 2400 x 1200mm, 2000 x 1200mm and 3000 x 2400mm.

See [Figure 10](#) for an example of a finished free standing cat enclosure, including an auxiliary unit.

### Tools required for the job:

- Tape measure
- Bolt cutters 450mm
- Angle grinder
- Pliers with wire cutter
- F clamps
- Roofing square
- Hammer

### Materials list

- 50 x 50mm galvanised weldmesh
- Tent pegs or masonry plugs
- Galvanised tie wire
- Dog clips
- Hardwood post 50x50mm

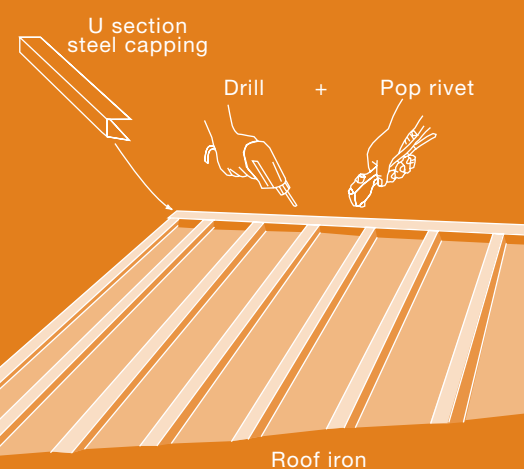

Figure 7: sheeting

## Step 1 Design and construction

Visit your steel supplier and obtain a list of stock sizes that are available and design the modules around these stock sizes to minimise off cuts. Cut the mesh with the angle grinder or bolt cutters and grind off sharp protrusions. Tie the panels together with tie wire. As cats do not dig deep enough to escape there is no need for a floor panel, and the enclosure can be held in place with either tent pegs or masonry plugs. For a door simply cut a small opening and cover with an oversize piece of mesh hinged on one side with tie wire or netting clips. The hinged door (which should open inwards) can be latched closed, with spring loaded clips (eg like dog clips). See [Figure 8](#). Depending on how flexible the mesh is, you may need to secure the door with multiple clips to prevent the cat from squeezing through gaps. If you prefer, the entire lid panel can be hinged to allow easy access.

## Step 2 Fittings

Each enclosure should provide a hardwood scratching pole, which can be fixed to an internal wall with tie wire. The enclosure also requires at least two levels of platforms that are joined by a climbing plank (platforms can either be supported by a stand or wired to the structure).

## Step 3 Access tunnels

The individual units are interconnected by tunnels, which can also be connected to the house via a cat door. See [Figure 10](#) for an example of a finished free standing cat enclosure, including tunnels.

These tunnels are made by folding a 900mm wide length of weldmesh and anchoring it to the ground. Either bend the 900mm wide weldmesh over in an arch and fasten it across the bottom with tie wire, or bend two right angles with the aid of a jig made from 2 lengths of hardwood and clamps. See [Figure 9](#). If a tunnel is to be suspended off the ground, the floor is made from 300mm wide lengths of steel cladding that is wired to the bottom of the tunnel with tie wire.

The tunnels are wired on to the component units and all protruding wire ends are folded back out of harm's way.

To give your cat an entertainment centre, put a birdbath within view just outside the enclosure. It doesn't seem to worry the birds and will provide your cat with hours of entertainment.

## Appendix

Supplier of prefab fittings (note there may be other suppliers who provide suitable prefab fittings, in addition to the supplier listed below)\*

### RMD Metal Products

6 Market Road  
Sunshine Vic 3020  
Ph: 03 9300 5109

[www.rmdmp.com.au](http://www.rmdmp.com.au)

<mailto:chowe@rmdpress.com.au>

\*The content of this Department of Primary Industries (DPI) document is provided for information purposes only. Information published by DPI is considered to be true and correct at the time of publication. DPI gives no representation or warranty as to the qualifications or suitability of the service providers listed, nor any representation or warranty that there are no other persons who provide services of this type as the list is not intended to be exhaustive.

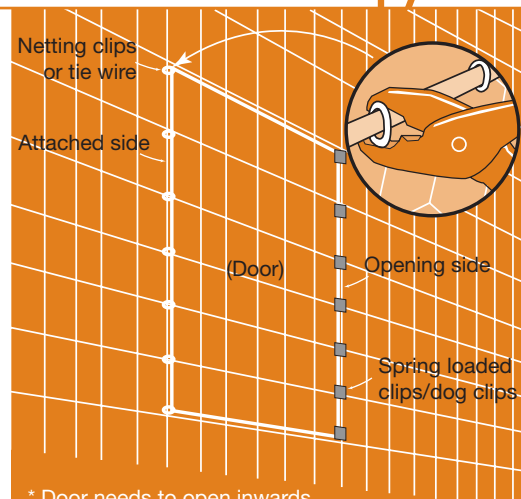

\* Door needs to open inwards

\*\* Enough dog clips to secure door needed so cat can't squeeze through gaps in flexible mesh

Figure 8: Design and construction of door



Figure 9: Tunnel bending

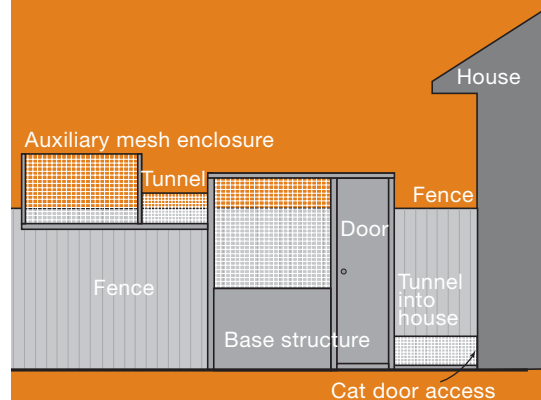

Figure 10: Sketch of finished free standing enclosure (base unit, auxiliary enclosure + tunnels)

Note: Figure 10 shows the basic building structure prior to the addition of other features (platforms, climbing planks, scratching posts, beds etc) as described in the text.

# THIS PUBLICATION IS FUNDED BY YOUR CAT REGISTRATION FEE

In addition, your cat registration fee funds:

- A council identification marker for your cat to wear.
- Lost and found service; a guarantee that if your cat is found wearing the council identification marker you will be notified.
- Council services to respond to calls about wandering dogs or dog attacks. This includes the removal of aggressive dogs from the streets, so you can walk in safety.
- Council services to deal with nuisance problems. These services manage issues like barking dogs, cat trespass, and unowned animals.
- Council control of 'dangerous', 'menacing' and 'restricted breed' dogs in your area. This ensures they do not pose a threat to the community.
- Council monitoring of pet shops, boarding kennels, catteries, pounds, shelters, and pet breeding and training businesses. This ensures they meet basic animal welfare standards required by law.
- A State Government education program for schools. This program makes visits to all Primary Schools in Victoria. It teaches children about how to be a responsible pet owner. For more information, see the website [www.pets.info.vic.gov.au](http://www.pets.info.vic.gov.au)
- A State Government education program for pre-schools. This program teaches children and parents how to avoid dog attacks in the home and in public places.
- A State Government education program for adults. This program promotes the responsible ownership of pets. It also provides advice and information for pet owners. For more detail, see the website [www.pets.info.vic.gov.au](http://www.pets.info.vic.gov.au)
- State Government research into cat and dog welfare and control issues.

Your local council may also provide any of the following:

- Education on how to be a responsible pet owner. This may include information such as the publication of brochures etc.
- Pet care days or discount microchipping days.
- Programs to subsidise the desexing of pets.
- Rewards for responsible pet owners.
- Activities to encourage dog owners to pick up dog faeces in public places. This may include education, fines, or providing bins and/or scoop facilities in parks.
- Signs for dog on-leash and off-leash areas, and patrols to check that dog owners comply.
- Education to prevent dog attacks.

Every cat and dog three months of age and over must be registered with your local council. Existing registrations must be renewed by 10 April each year.

#### **For more advice or information**

Call your local council if you have questions about your rights and responsibilities as a pet owner. Your council will also deal with concerns about wandering or nuisance pets.

Advice is also available from animal welfare shelters, vets and pet clubs. Visit [www.pets.info.vic.gov.au](http://www.pets.info.vic.gov.au) for contact details for such organisations, or call the DPI Customer Service Centre on 136 186 for the cost of a local call. You can also call the DPI Customer Service centre to order free responsible pet ownership brochures on a range of topics.

